



# Aston, Bayswater & Willow Collection



Contemporary & Traditional  
Gas Stove Range

### Why our flame is so natural...

Our range of balanced flue gas stoves gives a beautiful lazy dancing flame pattern which emulates that of a traditional wood burning stove and with the added features of being Clean, Odourless, Efficient & Easy to use.

### Our Technology & Engineering Excellence

From our modern manufacturing facility near the coast in West Glamorgan, South Wales we fully manufacture our range of both traditional and contemporary stoves. Our collection has been designed with the latest gas burning efficient technology, which is inherently safe, delivers a beautiful flame pattern with glowing log embers within an attractive looking stove which will be the key feature in any room.

The Aston & Bayswater stoves are fully controllable from 3.70kW up to 6.50kW allowing any room to warm quickly from cold. These stoves have a twin wall steel body system allowing the stove to produce radiant and convectional heat giving excellent heat distribution to any room, and give you an excellent view of the flame from whatever your position in the room.

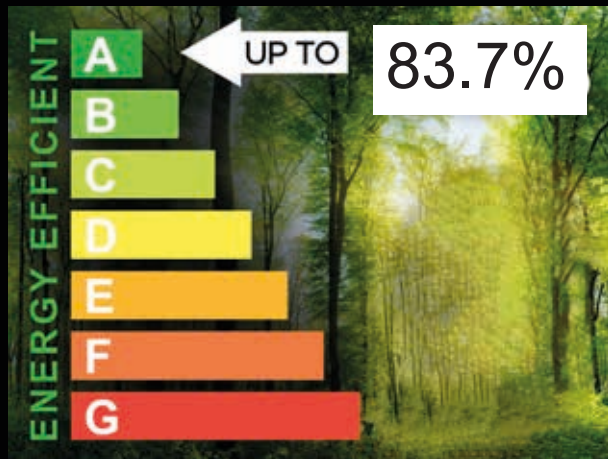

### Efficiency

All of our Balanced Flue gas stoves have an extremely high efficiency, testing up to 83.7%. This means they are rated "A" for efficiency as defined for a decorative balanced flue stove.

Whether it's our Exact Dual Burner with under log flame technology or our Linear Diagonal burner technology both options give a superior depth and height of flame



### Safety & Reliability

Our gas stove collection has been fully tested and certified in the UK by one of the leading global gas testing bodies, which fully conforms to the British standards and is fully UK CA accredited.

As with any gas appliance safety is of paramount importance, which is why we have built many additional safety features into our stoves to ensure safe and reliable performance



### Fully Remote Controlled

Our stoves are simple to use, you can just sit back and relax. The hand-held remote control allows you to control all of the features of the stove

You can also control the flame picture of the stove by the simple touch of a button, turning the flames from the highest setting to their lowest. Controllability at your fingertips and a fantastic flame picture give you all the advantages of a wood burning stove but none of the hard work.



**EXACT Dual Under Log Flame Burner** – Our unique burner technology gives these stoves a beautiful dancing flame, creating an authentic wood burning flame picture. The flames come from the dual burner system, there is a wide base burner which gives depth of flame plus under log flame technology from directly under the two angled campfire style logs. The unique Gas Valve System and the remote control that we use is fully manufactured in the UK.

*Picture of the flame from the Aston & Bayswater stove*



# ASTON GRANDE

Our Aston Grande is possibly our most eye-catching with its full frame windows giving you the maximum impact of the flame. The Aston's oval body shape also makes it a unique and stunning centrepiece.

- Fully Remote Controlled
- Electronic burner technology for variable flame picture
- High efficiency up to 83.7%
- Double glazed door and window side panels
- Extended panoramic curved glass door & side windows
- Convectional & Radiant heat output
- Exact Dual Burner design with under log flame technology
- Ceramic High Definition Log arrangement

Front View

Side View





Radiant & Convectional



Top Flue Exit



Double Glazed

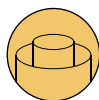

Balanced Flue



Remote Operation



Exact Dual Under Log Flame



2 Year Warranty

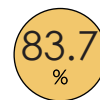

83.7 %

Efficiency



6.50 kW

Room Heat Output



75 mm

Rear Distance to Combustibles

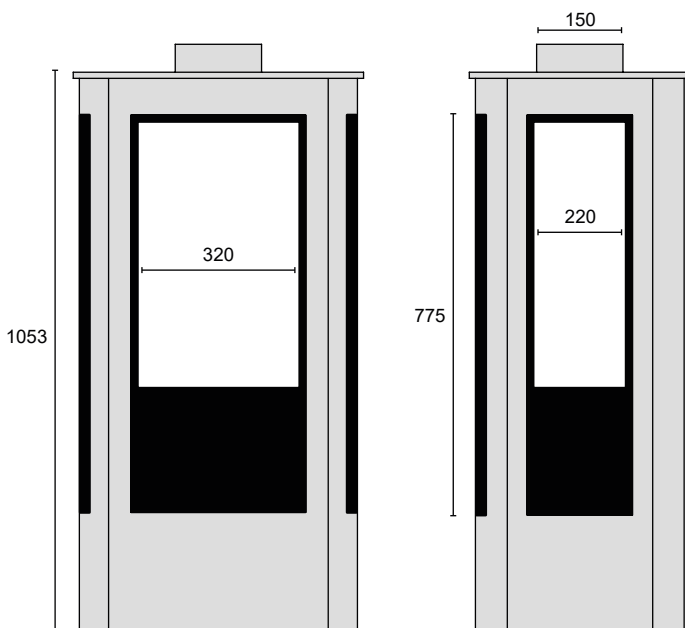

All dimensions are in millimetres (mm)

### Aston Technical Data:

- Maximum Heat Output to the room 6.50 kW
- Minimum Heat Output to the room 3.70 kW
- Energy Efficiency Rating A
- Weight Approx 70 Kgs
- Finish Matt Black
- Hearth Construction 12mm thick
- Valve Control Battery or Mains
- Exact Dual Flame Under Log Burner

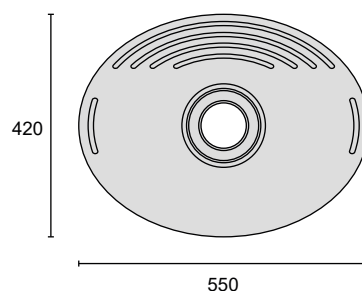



# BAYSWATER GRANDE

The Bayswater range of fully round bodied gas stoves available in Grande, Pedestal, Logstore and Compact options. Their dancing flame pattern will enhance and warm any room.

The Bayswater Grande is a contemporary style stove with a unique personality. Its bold lines make it stand out as a stunning centrepiece.

- Fully Remote Controlled
- Electronic burner technology for variable flame picture
- High efficiency up to 83.7%
- Double glazed door and window side panels
- Panoramic curved glass door & side windows
- Convective & Radiant heat output
- Exact Dual Burner design with under log flame technology
- Ceramic High Definition Log arrangement

Front View

Side View





Radiant & Convectional



Top Flue Exit



Double Glazed



Balanced Flue



Remote Operation



Exact Dual Under Log Flame



2 Year Warranty



Efficiency 83.7%



Room Heat Output 6.50 kW



Rear Distance to Combustibles 75 mm

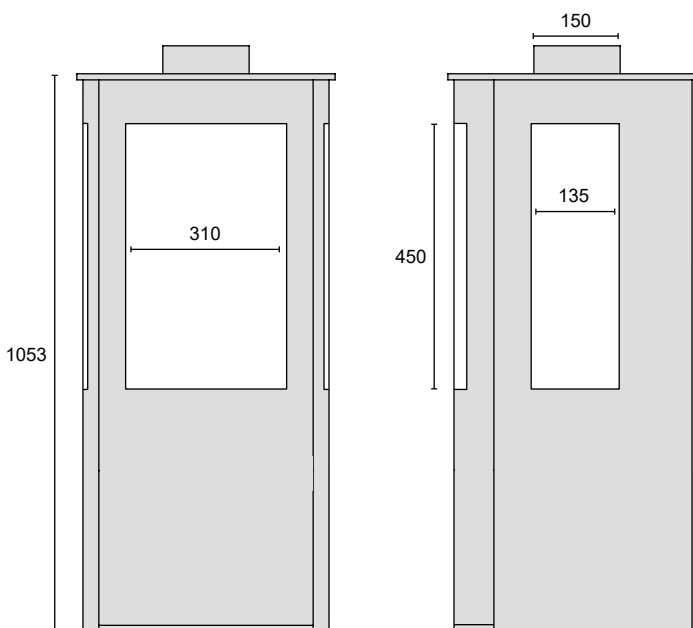

All dimensions are in millimetres (mm)

### Bayswater Technical Data:

- Maximum Heat Output to the room 6.50 kW
- Minimum Heat Output to the room 3.70 kW
- Energy Efficiency Rating A
- Weight Approx 61 Kgs
- Finish Matt Black
- Hearth Construction 12mm thick
- Valve Control Battery or Mains
- Exact Dual Flame Under Log Burner

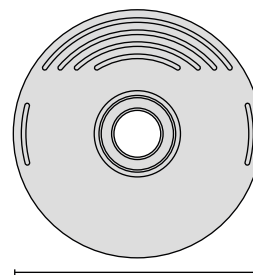

470





# BAYSWATER PEDESTAL

The Bayswater Pedestal is sleek and elegant with its large curved panoramic glass panel and one piece door. This allows the flame picture to be viewed from most angles in the room.

This free standing stove with its single round pillar offers an ultra modern feel to your home and becomes an attractive centrepiece in any room.

- Fully Remote Controlled
- Electronic burner technology for variable flame picture
- High efficiency up to 83.7%
- Double glazed door and window side panels
- Panoramic curved glass door & side windows
- Convectional & Radiant heat output
- Exact Dual Burner design with under log flame technology
- Ceramic High Definition Log arrangement

Front View



Side View







Radiant & Convectational



Top Flue Exit



Double Glazed



Balanced Flue



Remote Operation



Exact Dual Under Log Flame



2 Year Warranty



83.7 %



6.50 kW



75 mm

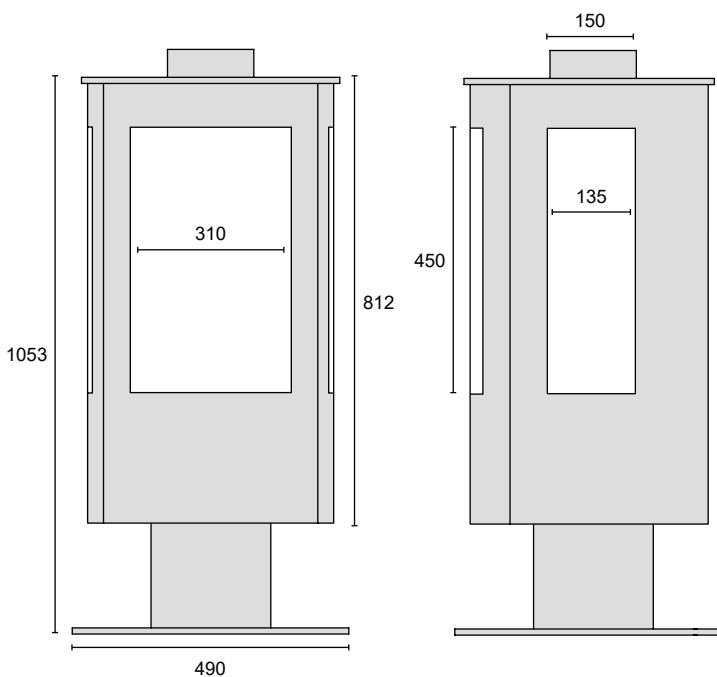

All dimensions are in millimetres (mm)

#### Bayswater Technical Data:

- Maximum Heat Output to the room
- Minimum Heat Output to the room
- Energy Efficiency Rating
- Weight Approx
- Finish
- Hearth Construction
- Valve Control
- Exact Dual Flame Under Log Burner

Available with or without side windows

- 6.50 kW
- 3.70 kW
- A
- 74 Kgs
- Matt Black
- 12mm thick
- Battery or Mains





# BAYSWATER COMPACT

The Bayswater Compact is modern and sophisticated. It has been specifically designed to be shorter in its overall height, yet it has exactly the same unique features as the Grande and Pedestal.

The Compact will fit into most fireplaces, however it looks fantastic and graceful either in an inglenook or free standing in a room with its modern sleek styling.

- Fully Remote Controlled
- Electronic burner technology for variable flame picture
- High efficiency up to 83.7%
- Double glazed door and window side panels
- Panoramic curved glass door & side windows
- Convectional & Radiant heat output
- Exact Dual Burner design with under log flame technology
- Ceramic High Definition Log arrangement

Front View



Side View





Radiant & Convectional



Top Flue Exit



Double Glazed

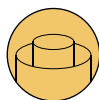

Balanced Flue



Remote Operation



Exact Dual Under Log Flame



2 Year Warranty

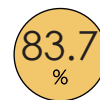

83.7 %

Efficiency



6.50 kW

Room Heat Output



75 mm

Rear Distance to Combustibles

**Bayswater Technical Data:**

- Maximum Heat Output to the room 6.50 kW
- Minimum Heat Output to the room 3.70 kW
- Energy Efficiency Rating A
- Weight Approx 55 Kgs
- Finish Matt Black
- Hearth Construction 12mm thick
- Valve Control Battery or Mains
- Exact Dual Flame Under Log Burner

Available with or without side windows

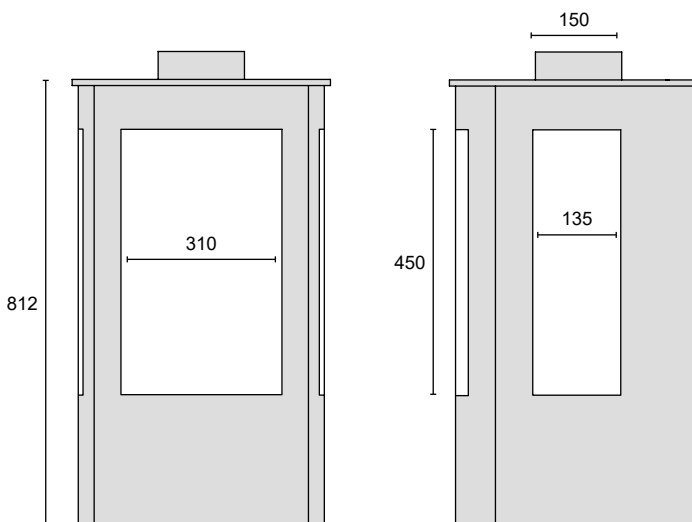

All dimensions are in millimetres (mm)

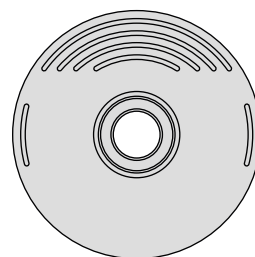

470





# BAYSWATER LOGSTORE

The Bayswater Logstore has been designed to look just like a contemporary wood burning stove but with the convenience of gas. Its modern lines allow it to be installed into contemporary or traditional styled rooms

On the Logstore model, you also have an open fronted storage compartment below the stove

- Electronic Fully Remote Controlled
- Electronic burner technology for variable flame picture
- High efficiency up to 83.7%
- Double glazed door and window side panels
- Panoramic curved glass door & side windows
- Convectional & Radiant heat output
- Exact Dual Burner design with under log flame technology
- Ceramic High Definition Log arrangement

Front View

Side View





Radiant & Convectonal



Top Flue Exit



Double Glazed



Balanced Flue



Remote Operation



Exact Dual Under Log Flame



2 Year Warranty

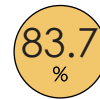

83.7 %



6.50 kW  
Room Heat Output



75 mm  
Rear Distance to Combustibles

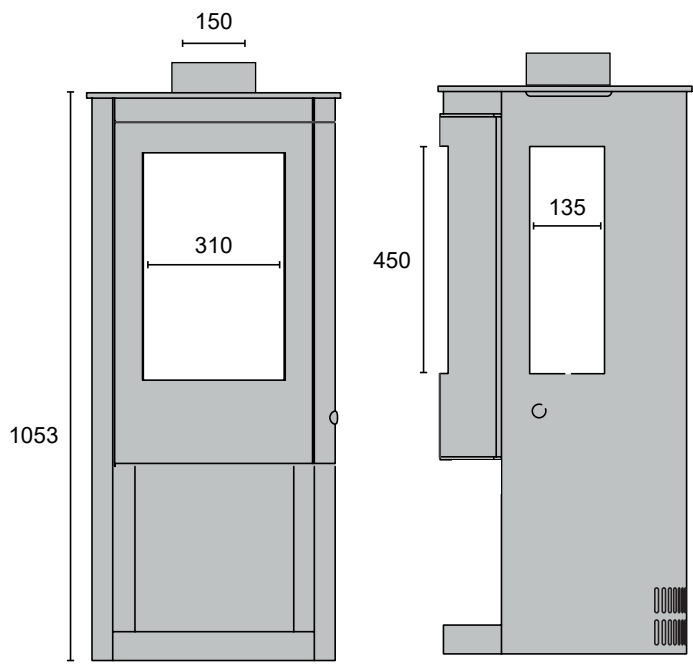

All dimensions are in millimetres (mm)

**Bayswater Technical Data:**

- Maximum Heat Output to the room 6.50 kW
- Minimum Heat Output to the room 3.70 kW
- Energy Efficiency Rating A
- Weight Approx 70 Kgs
- Finish Matt Black
- Hearth Construction 12mm thick
- Valve Control Battery or Mains
- Exact Dual Flame Under Log Burner

Available with or without side windows

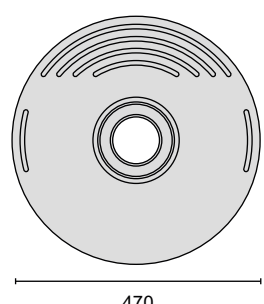

470





# Willow GRANDE

The Willow Grande stove has a huge panoramic glass panel, so you get the full effect of the dancing flames from any angle within your room. The Grande is perfect for any room, specially ones with larger fireplaces, with a room heat output of 5.60 Kw's and is extremely easy to use with the remote control.

- Fully Remote Controlled
- Electronic burner technology for variable flame picture
- High efficiency up to 83.1%
- Large panoramic double glazed door window
- Convectional & Radiant heat output
- Exact Dual Burner design with under log flame technology
- Ceramic High Definition Log arrangement



# Willow

## GRANDE LOGSTORE



Radiant & Convectional



Top Flue Exit



Double Glazed



Balanced Flue



Remote Operation



Exact Dual Under Log Flame



2 Year Warranty



83.1% Efficiency



5.60 kW Heat Output



Also available in Conventional Flue

The Willow Grande log store version allows the Grande gas stove to be raised off the floor and makes a great centrepiece in any room. Especially if there is no existing fireplace in the room. There is also an open fronted storage compartment below the stove

### Willow Grande Technical Data:

- Maximum Heat Output to the room 5.60 kW
- Minimum Heat Output to the room 3.60 kW
- Energy Efficiency Rating A
- Weight Approx Grande Stove only – 61 Kgs  
Logstove version – 82 Kgs
- Finish Matt Black
- Hearth Construction 12mm thick
- Valve Control Battery or Mains
- Exact Dual Flame Under Log Burner



Front View

Side View

Rear View

Log Store

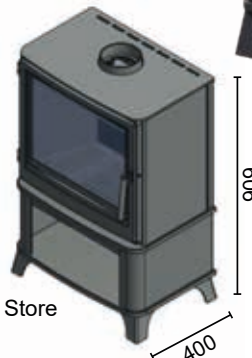
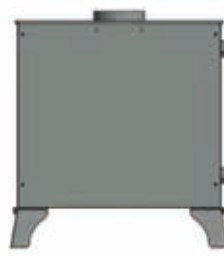
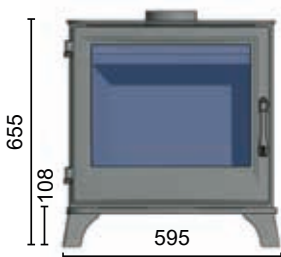

All dimensions are in millimetres (mm)





# Willow CLASSIC

The Willow Classic stove is stylish and elegant and is one of the highest performing stoves available on the market today with a total efficiency of over 83%. The Classic is easy to use and will enhance any room it is installed in, with a room heat output of 3.57 Kw's and is extremely easy to use with the remote control

- Fully Remote Controlled
- Electronic burner technology for variable flame picture
- High efficiency up to 83.2%
- Double glazed door window
- Convectional & Radiant heat output
- Linear Diagonal Flame Burner technology
- Ceramic High Definition Log arrangement





# Willow

## CLASSIC LOGSTORE



-   
 Radiant & Convectional
-   
 Top Flue Exit
-   
 Double Glazed
-   
 Balanced Flue
-   
 Remote Operation
-   
 2 Year Warranty
-   
 83.2% Efficiency
-   
 3.57 kW Heat Output
-   
 Linear Diagonal Burner
-   
 Also available in Conventional Flue

The Willow Classic log store version allows the Classic gas stove to be raised off the floor and makes a great centrepiece in any room. Especially if there is no existing fireplace in the room. There is also an open fronted storage compartment below the stove

### Willow Classic Technical Data

- Maximum Heat Output to the room 3.57 kW
- Minimum Heat Output to the room 2.39 kW
- Energy Efficiency Rating A
- Weight Approx
  - Classic Stove only – 52 Kgs
  - Logstove version – 69 Kgs
- Finish Matt Black
- Hearth Construction 12mm thick
- Valve Control Battery or Mains
- Linear Diagonal Flame Burner

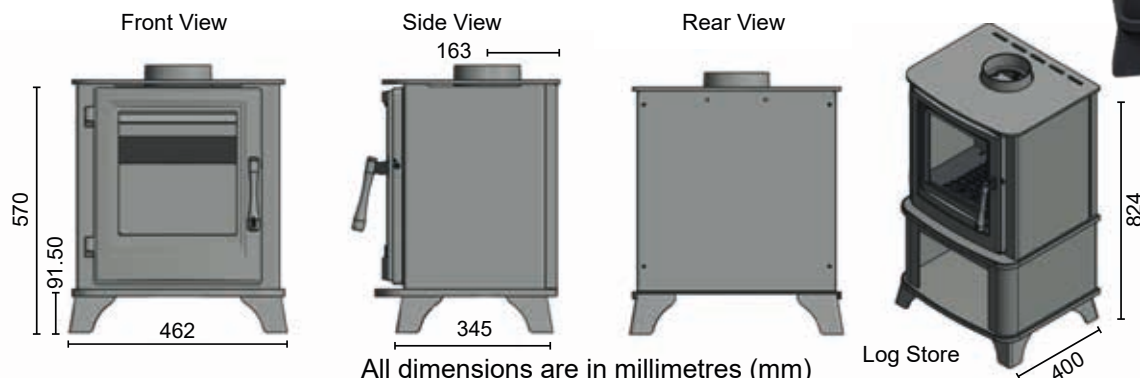

All dimensions are in millimetres (mm)

Log Store



# OUR TECHNOLOGY

## Balanced Flue – Efficiency & Heat Outputs

Stove Model	Stove Efficiency %	HIGH Flame Heat Output	LOW Flame Heat Output
Aston & Bayswater	83.7%	6.50 kW	3.70 kW
Willow Grande	83.1%	5.60 kW	3.60 kW
Willow Classic	83.2%	3.57 kW	2.39 kW

## Distances for Installation – for installation onto a straight wall or into a fireplace

	Minimum Clearance from Combustibles Materials		Minimum Clearance from Non - Combustibles Materials	
	Without Side Windows	With Side Windows	Without Side Windows	With Side Windows
<b>Aston &amp; Bayswater</b>				
Rear of Stove	75mm	75mm	50mm	50mm
Side of Stove	300mm	500mm	100mm	100mm
Front of Stove	Hot Zone 1000mm	Hot Zone 1000mm	Hot Zone 1000mm	Hot Zone 1000mm
<b>Willow Classic &amp; Willow Grande</b>				
Rear of Stove	250mm	N/A	50mm	N/A
Side of Stove	500mm	N/A	100mm	N/A
Front of Stove	Hot Zone 1000mm	Hot Zone 1000mm	Hot Zone 1000mm	Hot Zone 1000mm

When installing into a corner configuration please refer to the Operating & Installation Manual.

Please Note – when fitting a gas stove appliance, the installation must be by an approved & registered Gas Safe engineer and fully comply with Building Regulations

## Feature Guide



**EXACT Dual Under Log Flame Burner** -We use unique burner technology which gives our stoves that beautiful dancing flame, giving an authentic wood burning flame pattern & look. As the flames are coming from both the wide base burner which gives depth to the flame, and from directly under the two main angled logs



**Linear Diagonal Burner** – our Linear Diagonal burner allows the flame to come up into the logs diagonally across the burner from front to back giving a wide flame pattern with a natural & beautiful wood burning effect as the flames move between & around the logs

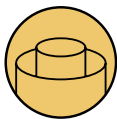

**Balanced Flue** - A twin walled flue, the inner tube expels emissions and the outer tube draws in clean air - See our flue kits opposite.

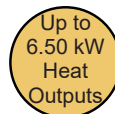

**Room Heat Outputs** - A huge constant heat output, but with the ability to instantly reduce or increase the heat with just a touch of the remote button. see table above for High & Low. Heat Outputs



**The Willow Grande & Willow Classic** are also available in Conventional Flue



**Rear Distance to Combustibles** - Our Aston & Bayswater stoves have a rear distance to combustibles of just 75mm, giving you more freedom of placement onto a straight flat wall – see table above for full dimensions



**2 Year Warranty** - All our gas stoves come with a 2 year manufacturers warranty, giving you peace of mind with your purchase. (Exclusions apply)



**Double Glazed** - All our gas stoves feature double glazed ceramic glass panels that give you a beautiful panoramic view of the fire.



**Remote Operation** - A hand held remote allowing full control of all the stoves features.



**Radiant & Convectional** - All our gas stoves are designed to produce radiant and convectional heat, allowing a better heat distribution into the room.



**Top Flue Exit** – Our stoves have a balanced flue top exit only. All our stoves are fitted with our flue collar which our balanced flue kits fit directly into.



**Stove Efficiency** - Our Balanced Flue stoves have been tested and achieved a super-high efficiency score making our stoves A Rated. – see table above for % efficiencies.

## Heat Distribution Output

Our stoves have a unique feature of radiant and convectional heat output. The diagram below illustrates how the stove draws in cool air from the room into the bottom of the stove and gently heats it up, outputting it as convectional heat from the top and sides.

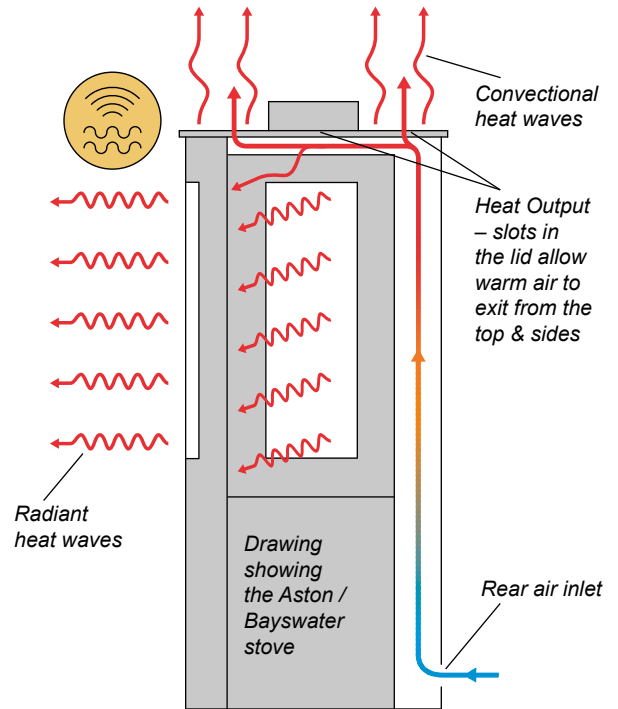

# BALANCED FLUE CONNECTIONS

## Gas Balanced Flue System

Our stoves use a modular stainless steel concentric balanced flue system, comprising of an inner and outer flue tube. Natural convection draws the clean air from outside into the stove via the outer tube, while the inner tube expels the combustion gases out.

Our standard flue kit is for a horizontal exit through the wall, it goes vertically up from the top of the stove 1000mm (item A /1000) then a 90 degree elbow (item B) into a 100/150 Horizontal Terminal Rain Cap End (item D) which is adjustable from around 360mm to 630mm which passes through the wall.

Our flue kit are painted in black to match the stoves are also available in the Stainless Steel finish

### Fitting using our concentric flue:

#### 1. Balanced Flue Kit 1

Qty	Ref	Description
1	A / 1000	1000mm Vertical Length
1	B	90 Degree Elbow
2	C	Integrated Locking Bands
1	D	100/150 Horizontal Terminal (Rain Cap End)

2. As well as exiting through an external wall via a 90 degree elbow joint using Flue Kit 1, you can also exit vertically through the ceiling and roof (up to 15 metres) using our concentric balanced flue system. The fittings for this are not included in our standard kits, please contact your retailer for further details.

### Fitting into an existing chimney:

3. Alternatively if you're not fitting your stove using one of our concentric flue systems (options 1 to 2), you can also install your stove into an existing fireplace with a suitable chimney. Therefore any of our gas stoves can be fitted into an existing fireplace opening using a conventional flue system, but a "Renovation Kit" must be used. Please contact your retailer for further details.

Specifications	
Diameter Range (mm):	Inner - 100mm, Outer - 130mm
Inner Liner Material:	0.4mm Grade 304L Stainless Steel
Outer Liner Material:	0.4mm Grade 304L Stainless Steel
Joint Method:	Push fit and locking band
CE Approved:	Yes
Minimum Vertical Flue Height:	1.0m
Maximum Vertical Flue Height:	15m

We also offer a range of other painted flue parts so if Kit 1 or Kit 3 does not fully meet your installation needs please call us for more details.

For Conventional Flue connections please refer to the Installation & Operating Manual

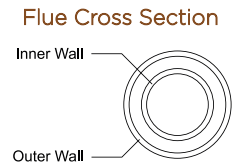
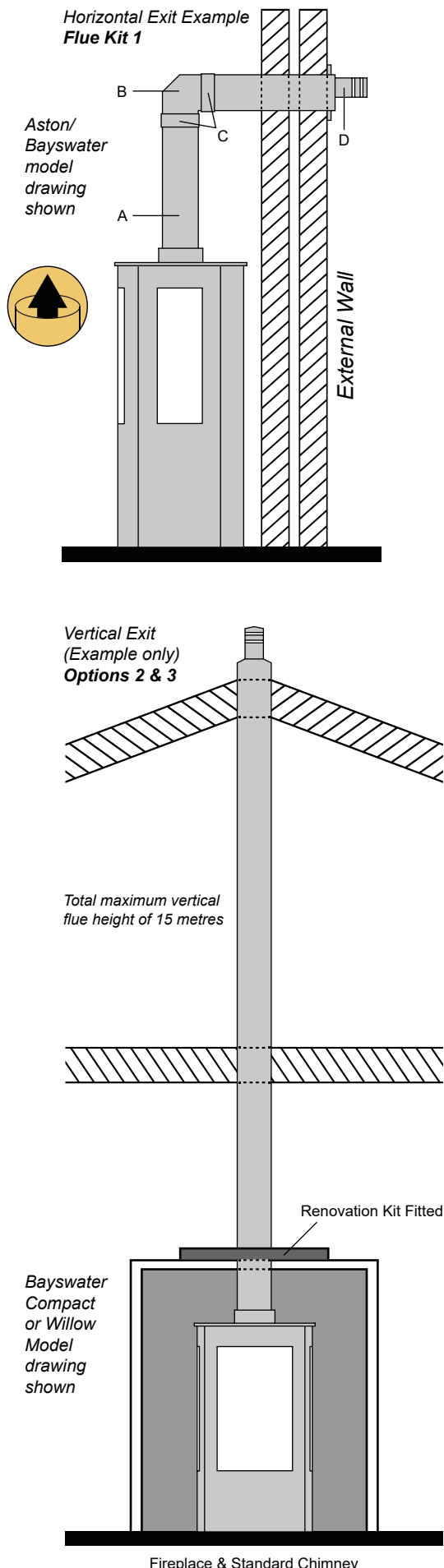



The four elements of nature:  
***Fire, Water, Earth & Air***

From the beginning of time we have always been attracted to a beautiful warming flame and glowing embers.

## Key features of the Leaf Stoves Gas Collection

- The Aston, Bayswater & Willow stoves are all balanced flue gas technology for high efficiency
- The Willow Grande & Classic stoves are also available in conventional flue format
- Panoramic Double Glazed ceramic door glass
- Large Double Glazed side window option
- Highly efficient and low running costs
- Gas Control management system is powered by batteries as standard or a mains electricity option
- Variable Heat outputs from 3.70 kW's to 6.50 kW's for the Aston & Bayswater stoves
- Fully remote controlled for all stove features
- Countdown Timer from the remote control
- Twin steel body system which produces radiant and conventional heat output On the Aston & Bayswater models
- Ceramic High Definition Log arrangement
- Fully conforms to the British Standards & UK CA accredited
- 2 year manufacturers warranty
- All our stoves and burners systems are 100% designed & manufactured in our factory in Wales
- Gas Valve and Remote Control fully manufactured in the UK

*All of our stoves are fully produced in the UK, a British Company, we Design with Passion and are Proud to Manufacture in the UK.*

*Leaf Stoves has a policy of continuous product improvement and development. Leaf Stoves reserves the right to change specifications and make modifications to the appliance described and illustrated at any time.*



Copyright © Leaf Stoves 2024

Leaf Stoves, 11 Village Farm Road, Village Farm Industrial Estate, Pyle, Bridgend, CF33 6BL

t: 0333 344 8605 e: sales@leafstoves.co.uk w: www.leafstoves.co.uk